

Congratulations, you have purchased the finest exhaust system available for your motorcycle. Your Vance & Hines exhaust is designed and crafted for performance, quality, and style. Please follow the instructions below, check exhaust system for missing or damaged parts and if you need any assistance please contact our technical support line (562) 921-7461.

FOR CLOSED COURSE COMPETITION USE ONLY. NOT INTENDED FOR STREET USE.

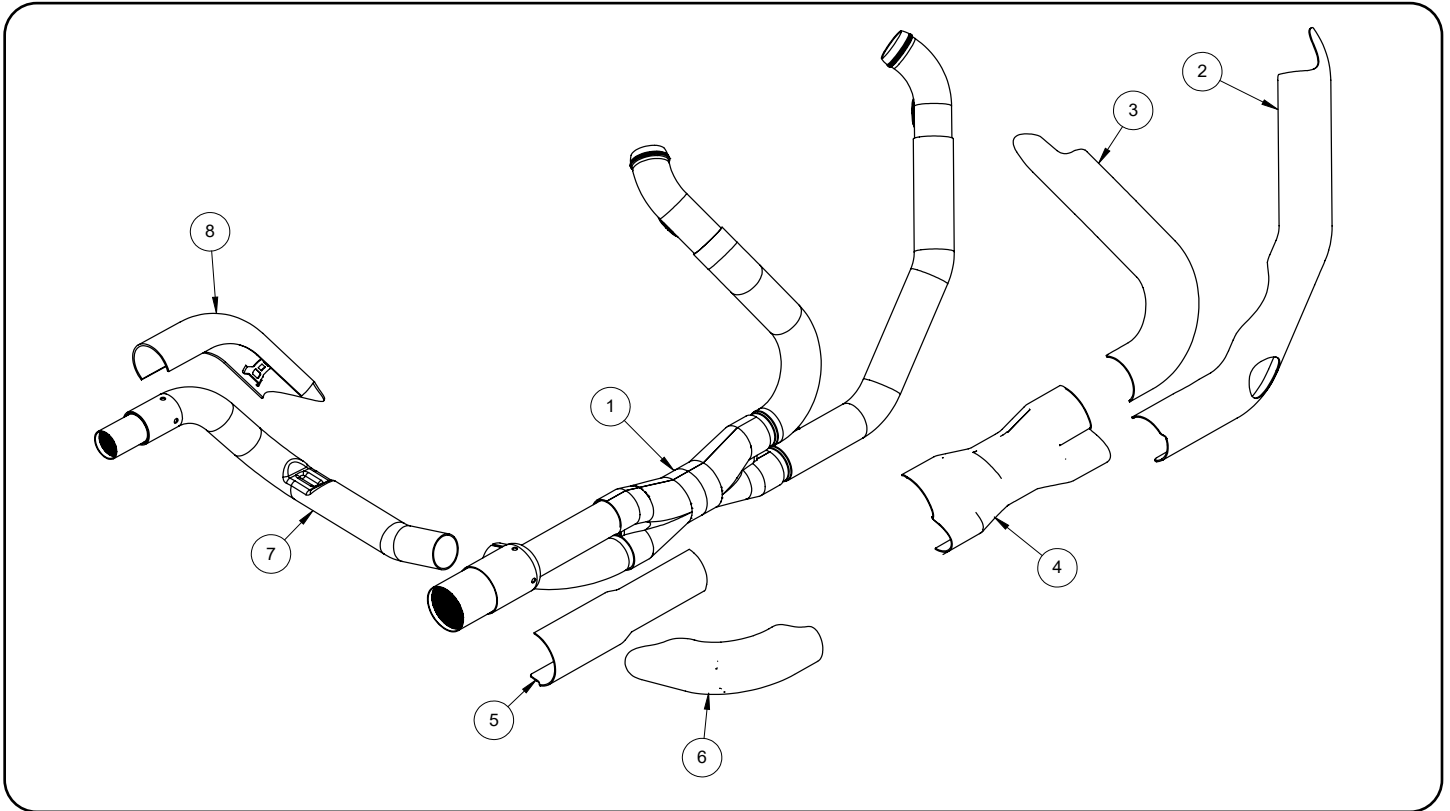

PARTS LIST

PART NO.	Description	Qty.				
			16	A240HW	5/16-18 x 5/8" FHS	1
1	D1150FC-C	1	17	1102-P	Crossover Bracket	1
2	D1350HP	1	18	A863CC	Crossover Tube Clamp	1
3	D1353HP	1	19	A265HW	3/8"-16 Lock Nut	1
4	D1352HP-S	1	20	A803HW	3/8"-16 Carriage Bolt	1
5	D855HP	1	21	A667HW	Floor Board Spacer, Rear	1
6	D857HP	1	22	A902HW	Floor Board Spacer, Front	1
7	D1154FC-C	1	23	1124-P	Bracket	1
8	D567HP	1	24	A286HW	3/8" Lock Washer	2
9	A288HW	2	25	A107HW	5/16" Flat Washer	1
10	A335HW	1	26	A106HW	3/8" Flat Washer	1
11	A776HW	1	27	A116HW	5/16" Lock Washer	1
12	A272HW	7	28	A644ST	18-12mm O2 Adaptor	2
13	A270HW	5	29	A197HW	Dog Bone Nut Plate	1
14	A828HW	1				
15	A826HW	1				

HARDWARE

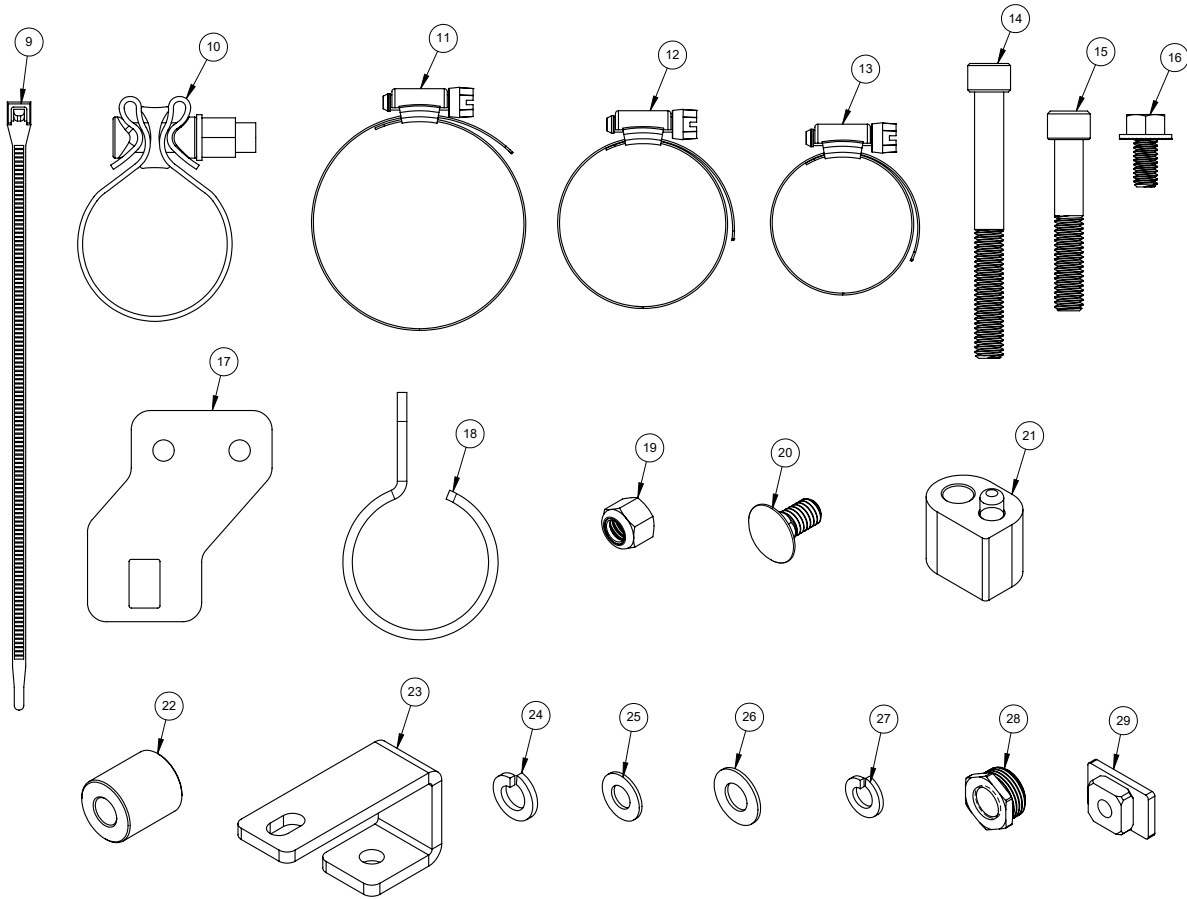

TOOLS REQUIRED

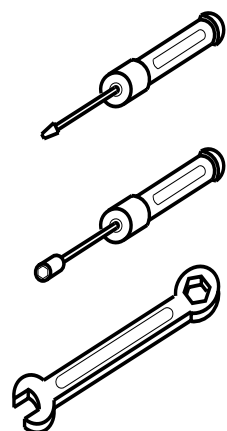

Flat blade screwdriver

5/16" Nutdriver

1/2", 9/16", 14mm, 17mm
Combination Wrenches

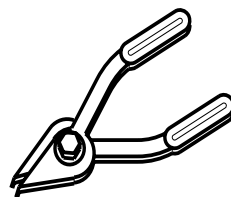

Snapping Pliers

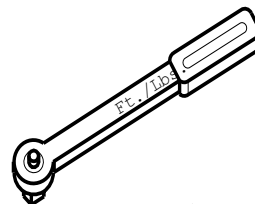

Ft.Lb. Torque Wrench

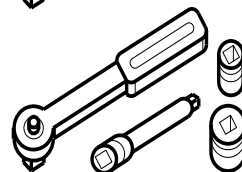

1/4" Ratchet &
Extensions

1/2", 3/4" Sockets

1/2", 9/16", 5/8", &
15mm deep sockets

3/16" & 5/16" Allen Sock-
ets

STOCK EXHAUST SYSTEM REMOVAL

1. Remove both left and right saddlebags and set them aside. Remove the right side panel.
2. Loosen the pinch clamp bolt on the front end of muffler(s). Save this for re-use.
3. Remove the two bolts and washers that mount the muffler(s) to the saddlebag supports. Save these for re-use.
4. Remove the stock muffler(s) and set aside. **NOTE:** It may be necessary to use a penetrating lubricant to loosen muffler(s) from the head pipe.
5. Locate and unplug the O2 sensor wires from the wiring harness (Grey and Black connectors located behind right side panel) and remove cable ties holding wires to frame. Feed the end of the wires through the frame so they are free from the motorcycle. **NOTE:** Pay attention to wire routing for re-installation.
6. Remove the right side floor board.
7. Remove the right side passenger floor board. (If equipped)
8. Loosen head pipe clamp connecting the left side muffler to the rear crossover header and the mount bracket on the backside of the oil pan. Remove the crossover section from the head pipe and the head pipe clamp. Save the clamp for re-use.
9. Remove the mount clamp located behind the oil pan. The mount will not be re-used. Save the bolts for re-use.
10. Remove nut from front headpipe mounting bracket located to the right of the transmission cover. Save for re-use.
11. Loosen the heat shield clamps on both front and rear exhaust pipes.
12. Remove the two flange mounting nuts from each head pipe, located at the cylinder head. Carefully remove the head pipes and set aside.
13. Carefully remove the O2 sensors from the stock head pipes and save for re-use with the new system.
14. Carefully remove the exhaust port flanges and circlips from the stock exhaust system using snapping pliers. **NOTE:** If circlips look bent or twisted, replace them.

VANCE & HINES EXHAUST INSTALLATION

1. Check the exhaust gaskets for damage, and replace if necessary. Part# 65324-83B
2. Remove header assembly and heat shields from protective packaging. Place each heat shield on a non-abrasive surface such as blanket or carpet. Using a felt tip pen, mark outside edge of each heat shield to show location of mounting clips that hose clamps will loop through (Figure 4).
3. The header assembly (D1150FC-C) will require heat shields stamped D1150HC, D1353HP, D857HP, D855HP, and D1352HP-S. The remaining heat shield D567HP will be used on the rear crossover header (D1154FC-C).
4. Install front headpipe mounting bracket onto stud located to the right of the transmission cover (Figure 1).

VANCE & HINES EXHAUST INSTALLATION CONTINUED

5. Lay header assembly into heat shields and loosely install the #20 and #28 hose clamps (supplied) into mounting clips. Screw heads should be accessible when the system is installed on motorcycle for adjustment purposes (Figure 4). Position front headpipe mounting bracket between middle and rear hose clamps. Do not tighten at this time.
6. Use the #28 hose clamps and install the collector heat shield (D1352HP-S) over the other heat shields. This can also be done after the header is installed if desired.
7. Apply a small amount of anti-sieze compound to the threads of the oxygen sensors and install them into the new head pipe. Install supplied 18mm to 12mm oxygen sensor adapter then install the 12mm oxygen sensors (Grey connector into the front head pipe, Black connector into the rear head pipe.) Models using 18mm wideband oxygen sensors install the sensor directly into the head pipe.
8. Install flanges and circlips from stock system onto the new header pipes.
9. Using stock flange nuts, carefully install the header assembly onto the motorcycle. Finger tighten only at this time.
10. Install front head pipe mounting bracket onto front head pipe using A197HW and A240HW (Figure 1).
11. Tighten exhaust port flange nuts.
12. Tighten front head pipe mounting bracket.
13. Attach crossover pipe clamp to bracket using carriage bolt, washer, and lock nut (supplied). Note: Carriage bolt should be placed through the square slot on the crossover mount bracket (Figure 3).
14. Install the Torca band clamp (supplied), with nut facing down on the expanded end of the head pipe.
15. Install crossover pipe clamp onto crossover pipe. The open end of the clamp should face the front of the motorcycle.
16. Loosely attach heat shield (D567HP) to the crossover pipe (D1154FC-S).
17. Slide crossover pipe into header. Tighten band clamp to muffler.
18. Install crossover mount bracket using stock hardware. (Figure 3)
19. Place the right muffler heat shield (D855HP) over the exposed upper pipe of the front header section. Tighten the heat shield using a #20 hose clamp. Leave the other clip empty until muffler is installed.
20. Install the mufflers of your choice onto both head pipes and secure to saddlebag supports with the stock bolts and lock washers.
21. Check alignment of mufflers and make corrections as required.
22. Tighten the Torca clamps securing the crosspipe and the mufflers to the head pipes.
23. Tighten the right muffler heat shield (D855HP) to the muffler using the #36 hose clamp.
24. Be sure to check that all fasteners including the hose clamps on the heat shields are tight. (See torque specifications in Harley-Davidson service manual).
25. Route the front (Grey) O2 sensor wire along OE path and plug into the Grey connector. Route the rear (Black) O2 sensor along the top of the transmission along the OE path and plug into the Black connector. Secure wires to the frame using supplied nylon cable ties.

VANCE & HINES EXHAUST INSTALLATION CONTINUED

26. Install 3/8" lock washers (supplied) on both 3/8"-16 (2.25" & 3.5" long) socket cap screws (supplied). Using these bolts re-install the floor board with two machined spacers (supplied) on the forward mount (A902HW) and back mount (A667HW). (Figure 2)
NOTE: Machined spacers are located between the floor board supports and floor board mount plate.
27. Re-install the right side passenger floorboard, right side panel, then saddlebags.
28. Be sure to tighten all hardware before starting your motorcycle.
29. After installation and before starting the motorcycle, completely clean pipes and mufflers with cleaning solvent and a clean soft cloth that will not leave residue. **NOTE:** Any residue, oil, or fingerprints will stain the finish when the metal heats up.

EXHAUST CARE

1. When installing a new set of black pipes, make sure your hands are clean and free of oil. After installation, thoroughly clean pipes with warm soapy water and a soft cloth. Dry with a clean towel to remove any residue before starting the motorcycle. Do NOT use anything abrasive to clean the pipes.
2. Avoid long periods of idling as this can cause discoloration.
3. Intake leaks can cause the engine to run lean and overheat, this could lead to discoloration.
4. Make sure there are no exhaust leaks at the junction of the exhaust pipes and cylinder head. We recommend replacing gaskets if they are worn.

FIGURE 1

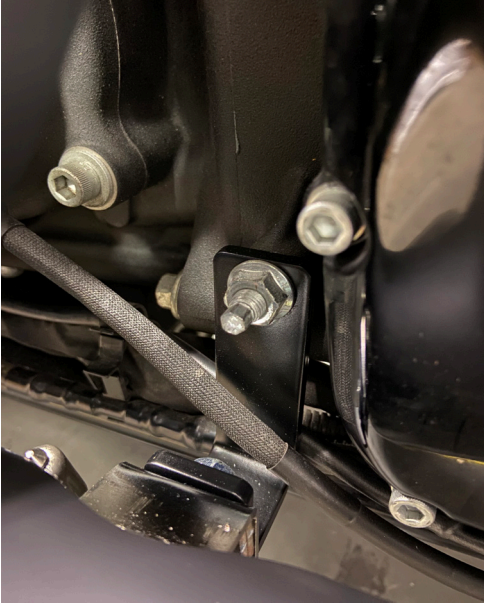

FIGURE 2



FIGURE 3



FIGURE 4

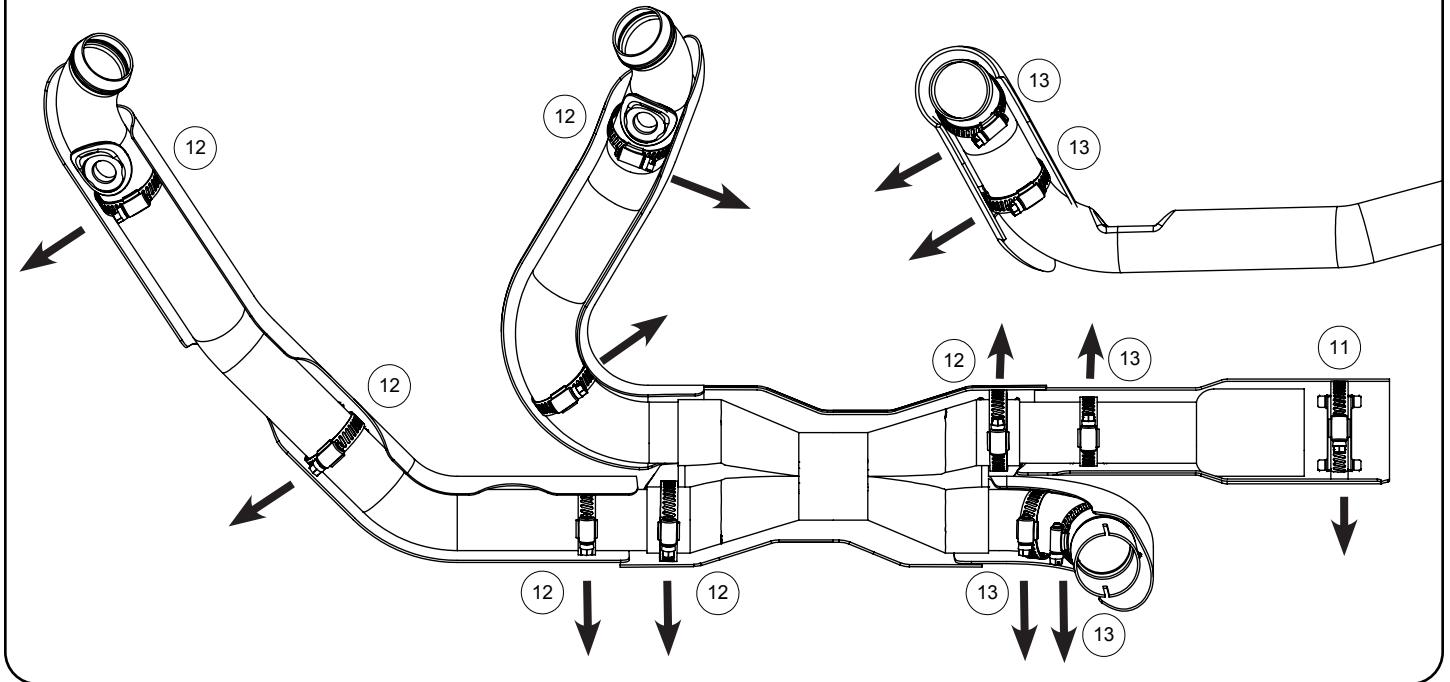

Emissions Notice:

In California, in order to meet Air Resources Board emissions requirements, certain aftermarket part applications have been identified as replacements, and others have received ARB Executive Orders. All other emissions related aftermarket parts are for competition use only. A list of replacement parts and EO parts, and corresponding fitment is provided at vanceandhines.com/california.

Warranty:

All Vance & Hines products are warranted against defects in material and workmanship for a period of 90 days. This warranty does not cover discoloration or rust. This warranty shall be limited to the repair or replacement of the product, which may be proven defective under normal use. Vance & Hines will not warranty any system that has been abused, misused, improperly installed or modified.

Dealers or distributors are not authorized to make dispositions binding upon Vance & Hines. Vance & Hines will not be responsible for any labor charges incurred in removing or replacing any system under warranty. A return authorization number and a copy of the original purchase invoice must accompany all returns. Parts returned without a return authorization may be refused.

Please Note: Every effort is made for Vance & Hines Exhaust Systems to provide improved cornering clearance. However, due to design and space limitations on some motorcycle models, ground and cornering clearance may not be improved and in some cases may be reduced. Be sure to follow proper installation instructions.

13861 ROSECRANS AVENUE / SANTA FE SPRINGS, CA 90670
SALES: (562) 921-5388
TECHNICAL: (562) 926-5291
FAX: (562) 802-0110

vanceandhines
.com